



Construction

Close-coupled, centrifugal pumps; electric motor with extended shaft directly connected to the pump.

NM: single-impeller

NMD: with two back-to-back impellers (with axial thrust balancing).

Connections: threaded ports ISO 228/1 (BS 2779).

NM, NMD: version with pump casing and lantern bracket in cast iron.

B-NM, B-NMD: version with pump casing and lantern bracket in bronze. (the pumps are supplied fully painted).

Applications

- For clean liquids without abrasives, which are non-aggressive for the pump materials (solids content up to 0.2%).
- For water supply.
- For heating, air-conditioning, cooling and circulation plants.
- For civil and industrial applications.
- For fire fighting applications. - For irrigation.

Operating conditions

Liquid temperature from -10 °C to +90 °C.

Ambient temperature up to 40° C.

Total suction lift up to 7 m.

Maximum permissible working pressure up to 10 bar (16 bar for pumps NMD 25/190; NMD 32/210; NMD 40/180). Continuous duty.

Motor

2-pole induction motor, 50 Hz (n = 2900 rpm).

NM, NMD: three-phase 230/400 V ± 10% up to 3 kW; 400/690 V ± 10% from 4 to 9,2 kW;

NMM, NMDM: single-phase 230 V ± 10%, with thermal protector. Insulation class F. Protection IP 54.

Classification scheme IE2 for three-phase motors from 0,75 kW.

Constructed in accordance with EN 60034-1; EN 60034-30. EN 60335-1, EN 60335-2-41.

Special features on request

- Other voltages.
- Frequency 60 Hz (as per 60 Hz data sheet).
- Protection IP 55. - Special mechanical seal
- Higher or lower liquid or ambient temperatures.

Materials

Components	NM, NMD	B-NM, B-NMD
Pump casing Lantern bracket	Cast iron GJL 200 EN 1561	Bronze G-Cu Sn 10 EN 1982
Impeller	Brass P- Cu Zn 40 Pb 2 UNI 5705	
NM 17	Cast iron GJL 200 EN 1561	Bronze G-Cu Sn 10 EN 1982
Shaft	Cr steel AISI 430	Cr Ni Mo steel AISI 316
	Cr Ni steel AISI 303 1,1 -1,5 - 2,2 kW	
Mechanical seal	Carbon - Ceramic - NBR	

Coverage chart n ≈ 2900 rpm

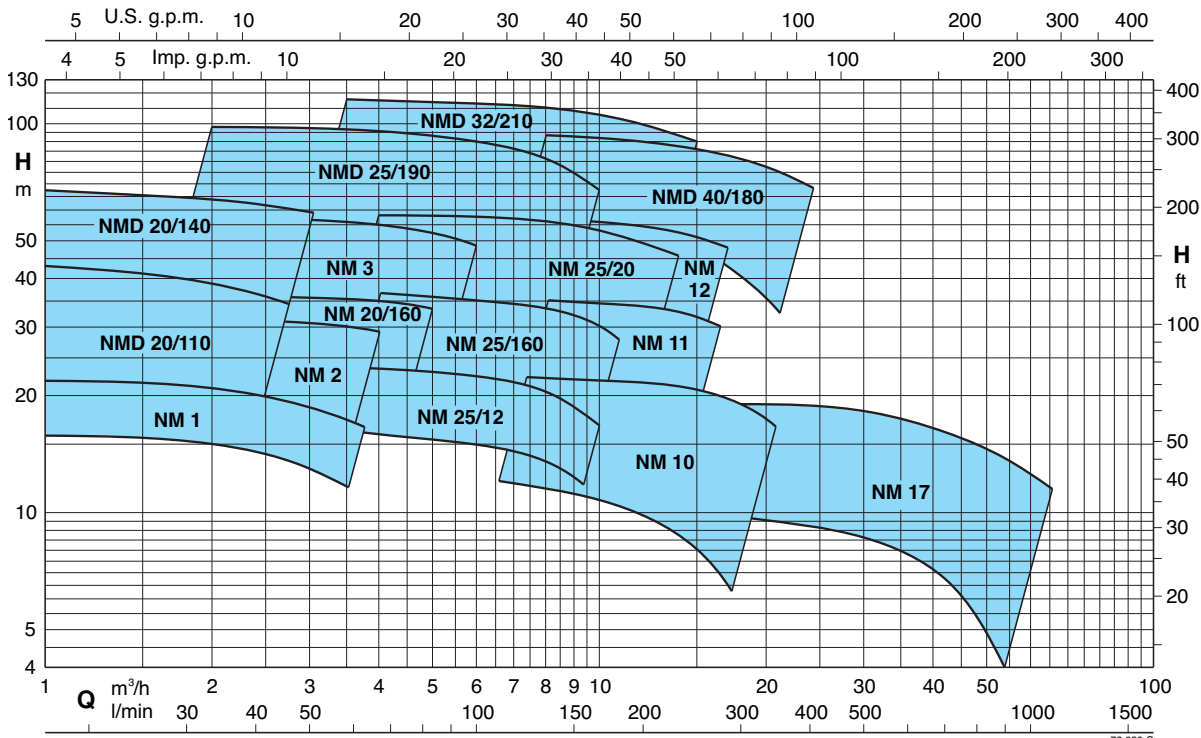

Performance n ≈ 2900 rpm

	NM	P ₂		Q m ³ /h															
		kW	HP																
				l/min	1	1,2	1,5	1,89	2,4	3	3,6	4,2	4,8	5,4	6	6,6	7,5	8,4	
					16	20	25	31,5	40	50	60	70	80	90	100	110	125	140	
	NM 1/AE●	0,37	0,5	H m	22	21,6	21,3	20,9	20,3	19,4	18,1	16,3							
	NM 2/B/A●	0,55	0,75		27	26,5	26	25,5	25	24	23	22	20						
	NM 2/S/A●	0,55	0,75		31	30,5	30	29	27,5	25,5	23,5	20	16						
	NM 2/A/A●	0,75	1		33,5	33	32,5	32	31,5	30,5	29,5	28,5	27	26	24				
	NMM 3/CE	1,1	1,5			37,5	37,5	37	36,5	36	35	34	32						
	NM 3/CE	1,1	1,5			37,5	37,5	37	36,5	36	35	34	32	30,5*	28,5*				
	NMM 3/BE	1,5	2			42	42	41,5	41	40,5	40	39	37	35*	32*				
	NM 3/BE	1,5	2			47	47	46,5	46	45,5	45	44	43	41,5*	40*	37,5*	33*	26*	
	NM 3/A/A	2,2	3			56	55,5	55,5	55	54,5	53,5	52,5	51,5	50*	48*	46*	42*	36*	

B-NM B-NMD	NM NMD	P ₂		Q m ³ /h															
		kW	HP																
				l/min	16	20	25	31,5	40	50	60	70	80	90	100	110	125	140	
B-NMD 20/110B/A●	NMD 20/110B/A●	0,45	0,6	H m	33	32	31	29	26,5	23	18								
B-NMD 20/110Z/A●	NMD 20/110Z/A●	0,55	0,75		37	36	35	33	30,5	27,5	23	18*							
B-NMD 20/110A/A●	NMD 20/110A/A●	0,75	1		43	42	40,5	39	36,5	33	29	25*							
B-NMDM 20/140BE	NMDM 20/140BE	1,1	1,5		52	51,5	51	50	48,5	47	45								
B-NMD 20/140BE	NMD 20/140BE	1,1	1,5		53	52,5	52	51	50	48	46	43,5	40						
B-NMDM 20/140AE	NMDM 20/140AE	1,5	2		57,5	57	56,5	55,5	54	51,5	49	46	43	40	36				
B-NMD 20/140AE	NMD 20/140AE	1,5	2		67	66,5	66	64,5	63	61,5	59	57	53,5	50	46				
B-NM 20/160BE●	NM 20/160BE●	0,75	1					30,5	30	29,5	28,5	27,5	26,5	25,5	24	22*			
B-NM 20/160AE●	NM 20/160AE●	1,1	1,5					36	35,5	35	34,5	33,5	32	30,5	29	27*			

B-NM B-NMD	NM NMD	P ₂		Q m ³ /h															
		kW	HP																
				l/min	40	50	60	80	100	110	125	140	160	180	200	220	250	280	
B-NM 25/12B/A●	NM 25/12B/A●	0,55	0,75	H m	20	19,9	19,8	19,3	18,5	18	17,3	16,3	15*	13,2*	11*				
B-NM 25/12A/A●	NM 25/12A/A●	0,75	1		23,5	23,4	23,3	22,9	22,1	21,7	20,9	20	18,7*	17,1*	15,2*				
B-NM 25/160BE●	NM 25/160BE●	1,1	1,5			31	30,7	30	28,5	28	27	26	23						
B-NM 25/160AE●	NM 25/160AE●	1,5	2			36,5	36,2	35,5	34,5	34	33,5	32,5	31	28,5*	26*				
B-NM 25/200B/A	NM 25/20B/A	2,2	3			42,5	42	41	40	39,5	38,5	37,5	36	33*	29*				
B-NM 25/200A/A	NM 25/20A/A	3	4			50	49,7	49	48	47,5	47	46,5	45,5	44*	42*	39*			
B-NM 25/200S/A	NM 25/20S/A	4	5,5			59	58,5	58	57,5	57	56,5	55,5	54,5	53	51,5	49*	44,5*	37*	
B-NMD 25/190C/A	NMD 25/190C/A	2,2	3			62	60,5	59	55,5	51	48,5	44	38*						
B-NMD 25/190B/A	NMD 25/190B/A	3	4			76	75	74	70	66	64	60	54	46*					
B-NMD 25/190A/A	NMD 25/190A/A	4	5,5			98	97	96	93,5	90	88	84	79	70*					

	NM	P ₂		Q m ³ /h															
		kW	HP																
				l/min	110	125	140	160	180	200	220	250	280	315	350	400	450	500	
	NM 10/FE●	0,55	0,75	H m	12,5	12,5	12	11,5	11	10	9	7,5							
	NM 10/DE●	0,75	1		18	18	17,5	17	16,5	16	15,5	14							
	NM 10/AE●	1,1	1,5		23	23	22,5	22	21,5	21	20,5	19							
	NM 10/SE●	1,5	2		23,5	23,5	23	22,5	22	21,5	21	20,5	19*	18,5*	16,5*	13*			
	NMM 11/BE	1,5	2		26,5	25,5	25	24	23	22,5	21,5	19,5	17,5						
	NM 11/BE	1,5	2		29,5	29,5	29	28,5	27,5	27	26	25*	22,5*						
	NM 11/A/A	2,2	3		35,5	35,5	35	34,5	34	33,5	33	32*	30*						
	NM 12/D/A	2,2	3		38	37,5	37	36	35	33,5	32								
	NM 12/C/A	3	4		45	44,5	44	43,5	42,5	41	40	38	36*						
	NM 12/A/A	4	5,5		57,5	57	56	55,5	55	54,5	53,5	51,5	49*						

Performance n ≈ 2900 rpm

1

B-NMD	NMD	P ₂		Q m ³ /h l/min	5,4	6	6,6	7,5	8,4	9,6	10,8	12	13,2	15	16,8	18,9	21	24
		kW	HP		90	100	110	125	140	160	180	200	220	250	280	315	350	400
B-NMD 32/210D/A	NMD 32/210D/A	4	5,5	H m	71	69	67,5	65	62,5	58	53	46	37*					
B-NMD 32/210C/A	NMD 32/210C/A	5,5	7,5		84	83	82	81	79	76	73	69	64*	54*				
B-NMD 32/210B/A	NMD 32/210B/A	7,5	10		104	103	102	100	98	95	92	88	84*	76*				
B-NMD 32/210A/A	NMD 32/210A/A	9,2	12,5		114	113	112	110	108	105	103	99	96*	90*				
B-NMD 40/180D/A	NMD 40/180D/A	4	5,5					60	59,5	57	56	53	51,5	48	44	39	34*	25*
B-NMD 40/180C/A	NMD 40/180C/A	5,5	7,5					69	68	67	66	64,5	63	60	57	53	48*	40*
B-NMD 40/180B/A	NMD 40/180B/A	7,5	10					87	86	85	84	82,5	81	78	75	71	66*	59*
B-NMD 40/180A/A	NMD 40/180A/A	9,2	12,5					94	93	92	91	89,5	88	85	82	78	74*	67*

B-NM	NM	P ₂		Q m ³ /h l/min	21	24	27	30	33	37,8	42	48	54	60	66	75	84	96
		kW	HP		350	400	450	500	550	630	700	800	900	1000	1100	1250	1400	1600
B-NM 17/HE●	NM 17/HE●	1,1	1,5	H m	9,5	9,2	9	8,6	8,2	7,5	6,7	5,5	3,5*					
B-NM 17/GE●	NM 17/GE●	1,5	2		12	11,7	11,5	11,2	11	10,3	9,7	8,5	7*	4*				
B-NM 17/F/A	NM 17/F/A	2,2	3			16	16	15,5	15	14,5	14	13	11,5*	10*	8*			
B-NM 17/D/A	NM 17/D/A	3	4					18	18	17,5	17	16,5	15,5	14*	13*	11,5*		

NM, NMD Standard construction.
B-NM, B-NMD Bronze construction.

P₂ Rated motor power output.
H Total head in m.

● With single-phase motor = NMM - NMDM.
* Maximum suction lift 1-2 m.
Tolerances according to ISO 9906, annex A.

Rated currents

P ₁ kW	P ₂		230 V 1~ IN A	IA/IN	P ₂		230 V Δ / 400 V Y 400 V Δ / 690 V Y			IA/IN
	kW	HP			kW	HP	IN A	IN A	IN A	
0,62	0,37	0,5	3	2,7	0,37	0,5	2,3	1,3		3,8
0,72	0,45	0,6	3,6	2,9	0,45	0,6	2,3	1,3		3,5
0,91	0,55	0,75	4,5	3,1	0,55	0,75	3	1,7		4,3
1,2	0,75	1	5,8	3	0,75	1	3,8	2,2		3,9
1,6	1,1	1,5	7,4	3	1,1	1,5	4,7	2,7		5,6
2	1,5	2	9,2	3,8	1,5	2	7,5	4,3		5,5
					2,2	3	9,2	5,3		7,4
					3	4	11,5	6,6		8,2
					4	5,5		9,6	5,5	7,6
					5,5	7,5		10,9	6,3	9,1
					7,5	10		14,3	8,3	9,1
					9,2	12,5		18,5	10,7	8,2

P₁ Maximum power input.
P₂ Rated motor power output.
IA/IN D.O.L. starting current / Nominal current

Characteristic curves $n \approx 2900$ rpm

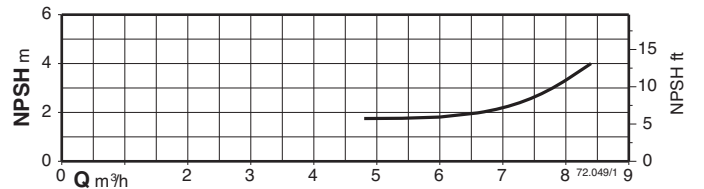
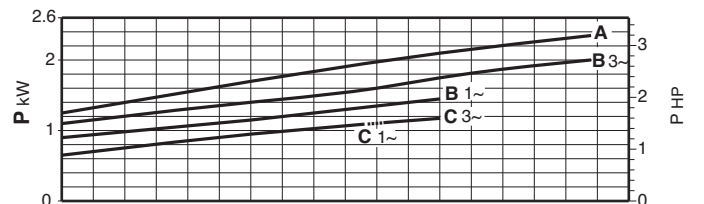
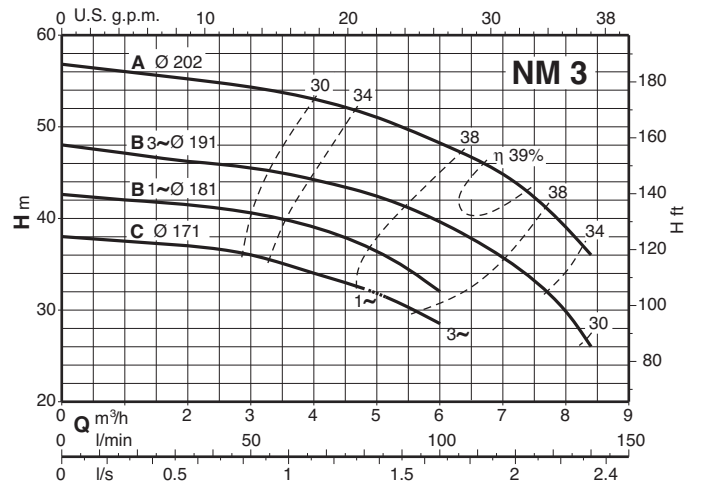
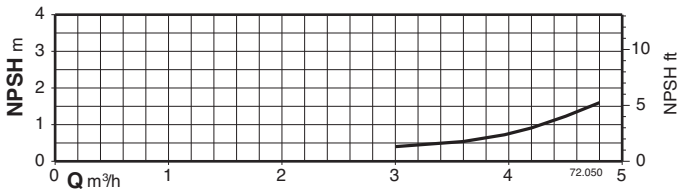
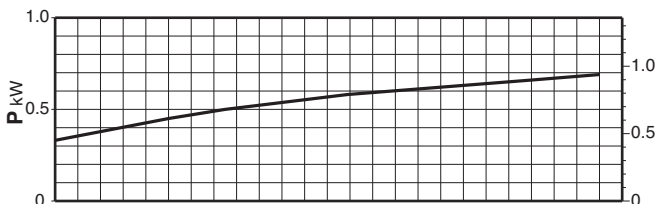
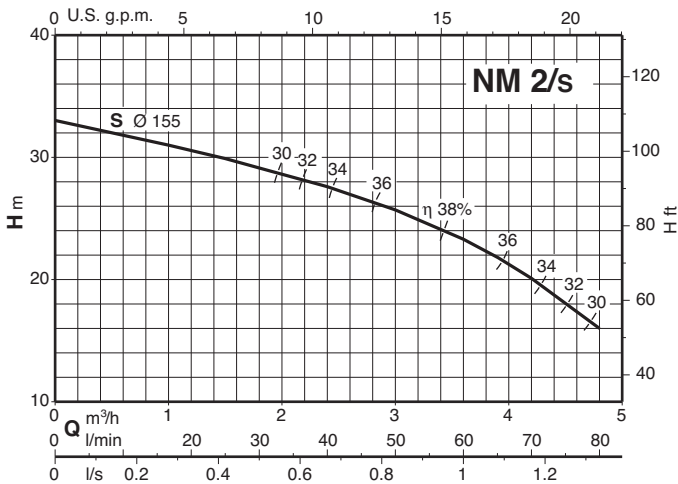
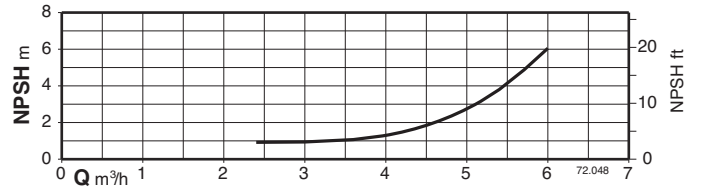
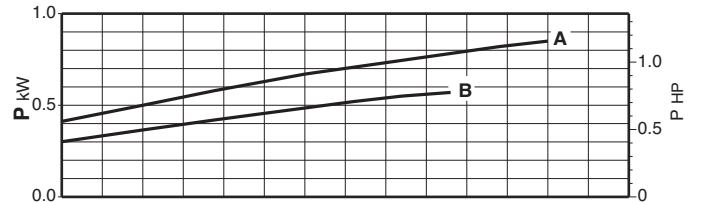
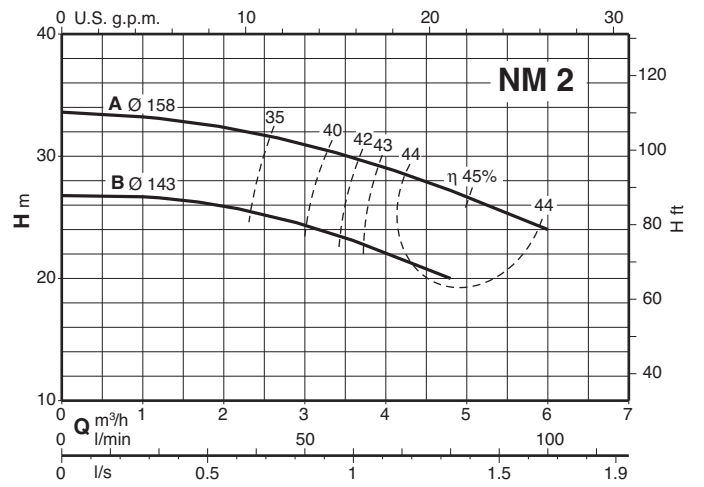
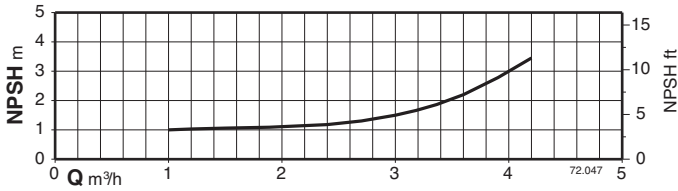
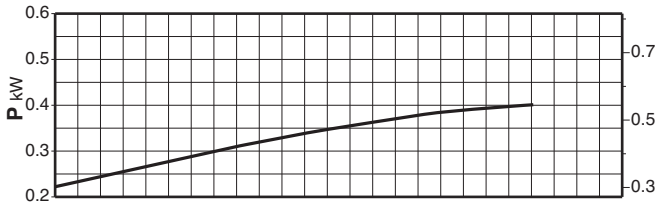
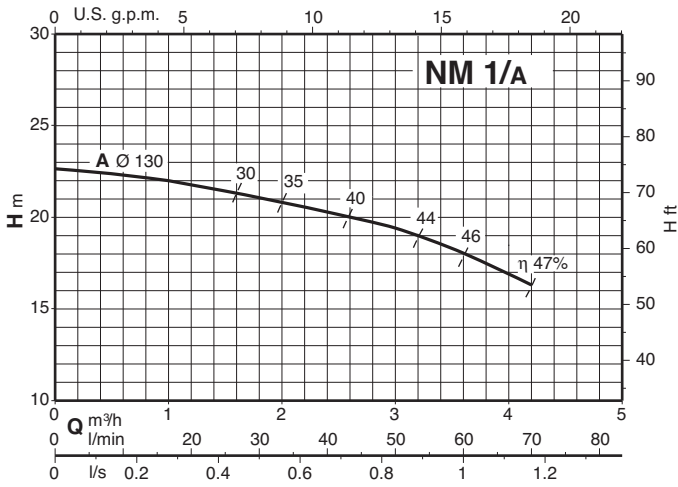

Characteristic curves $n \approx 2900$ rpm

1

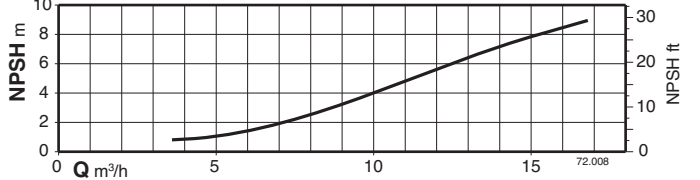
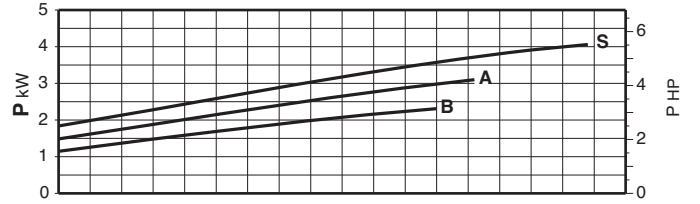
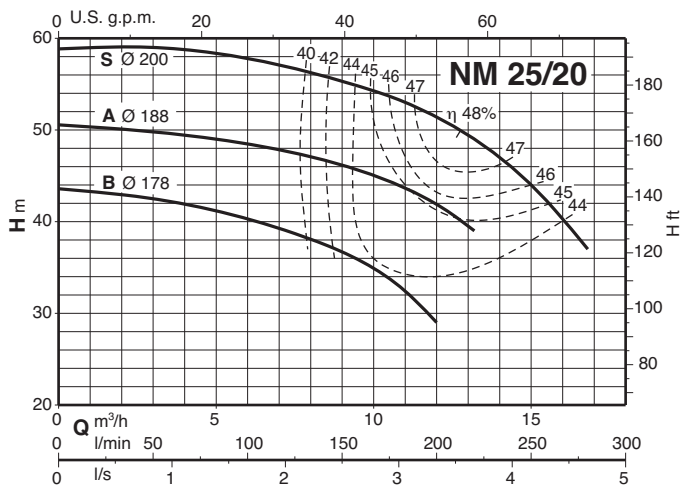
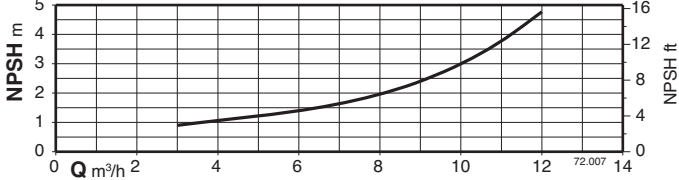
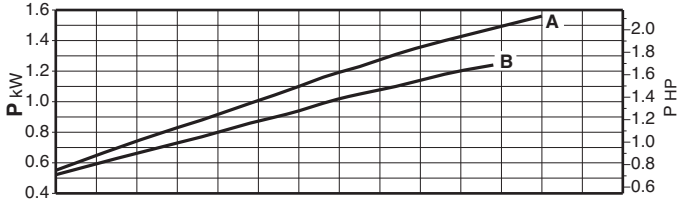
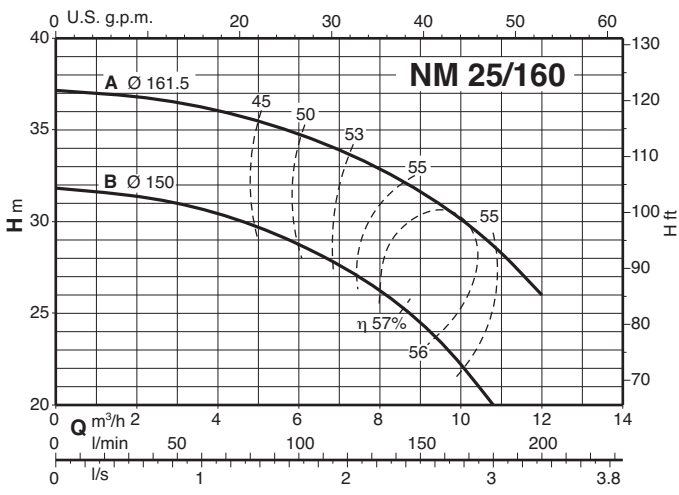
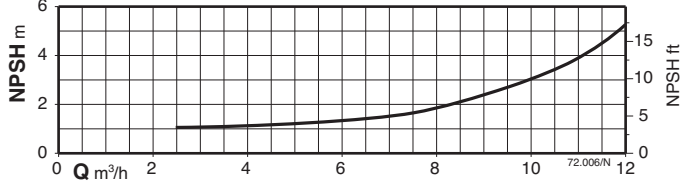
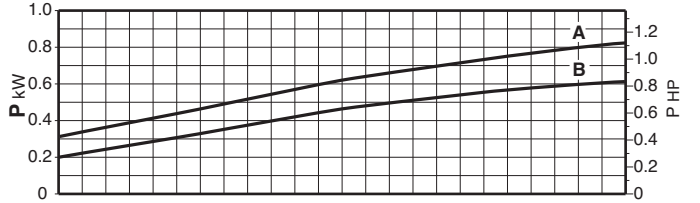
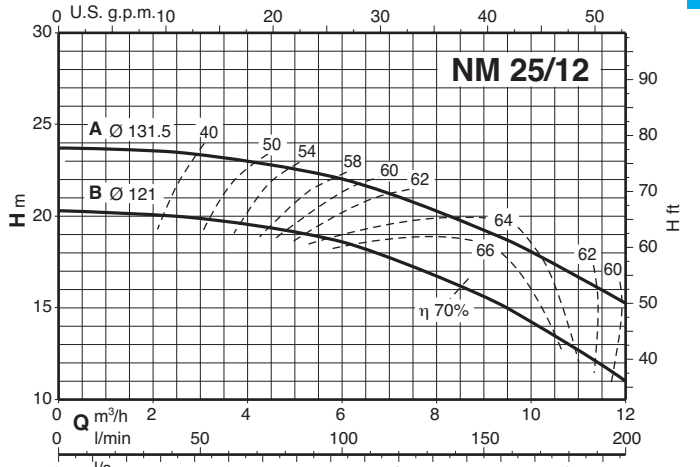
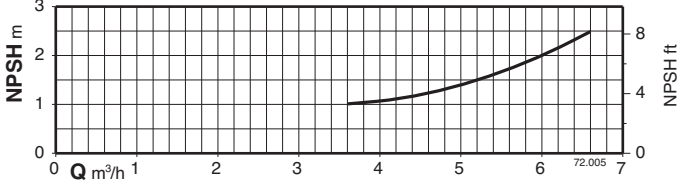
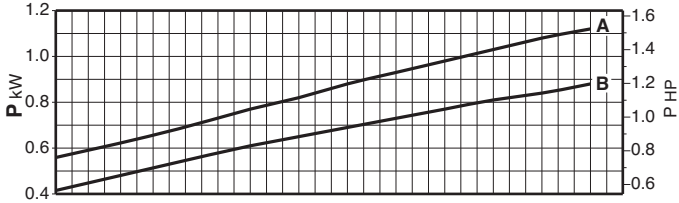
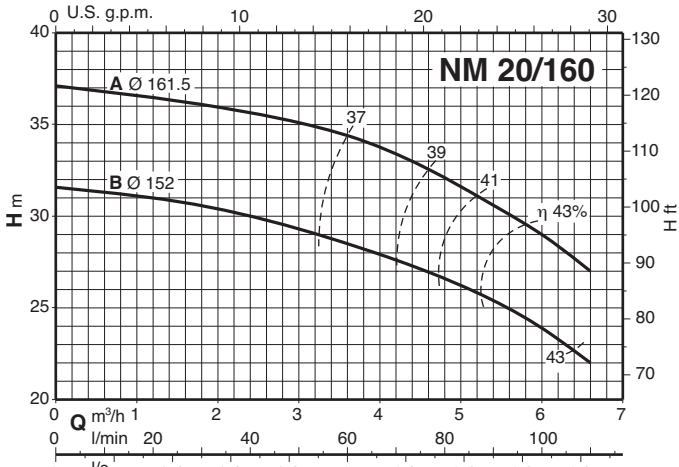

Characteristic curves $n \approx 2900$ rpm

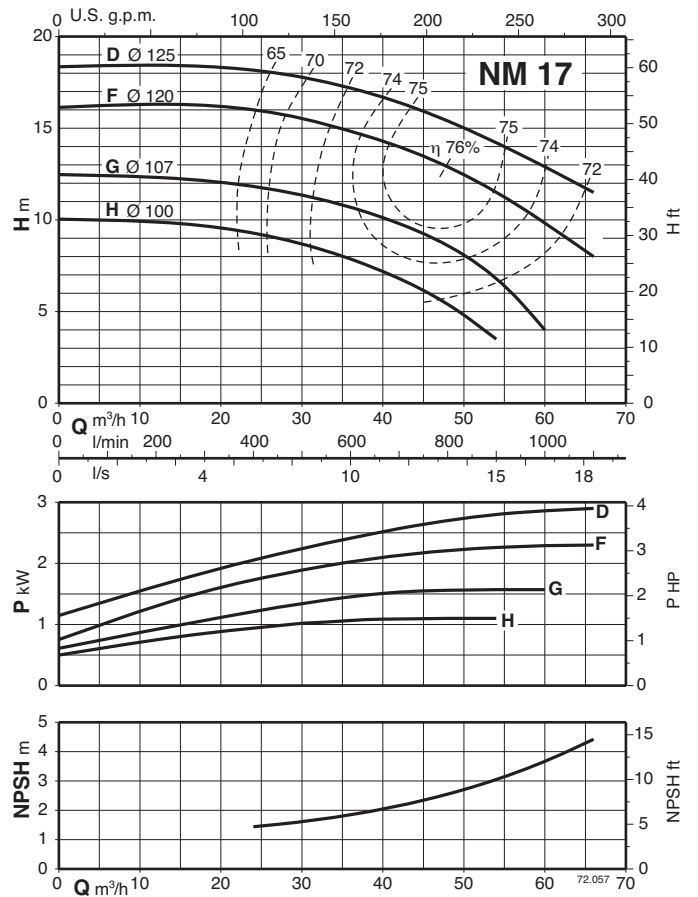
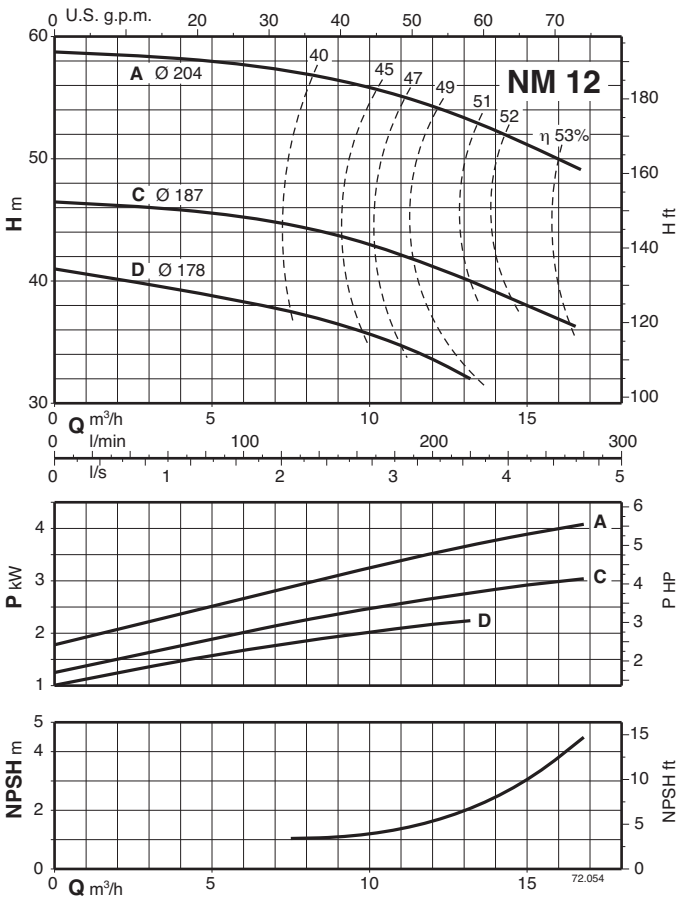
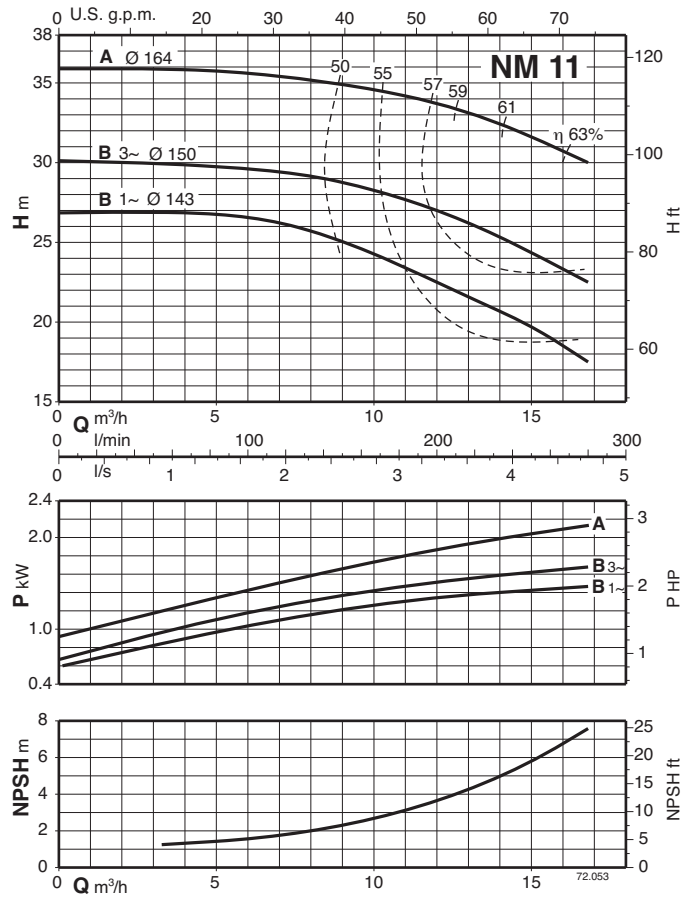
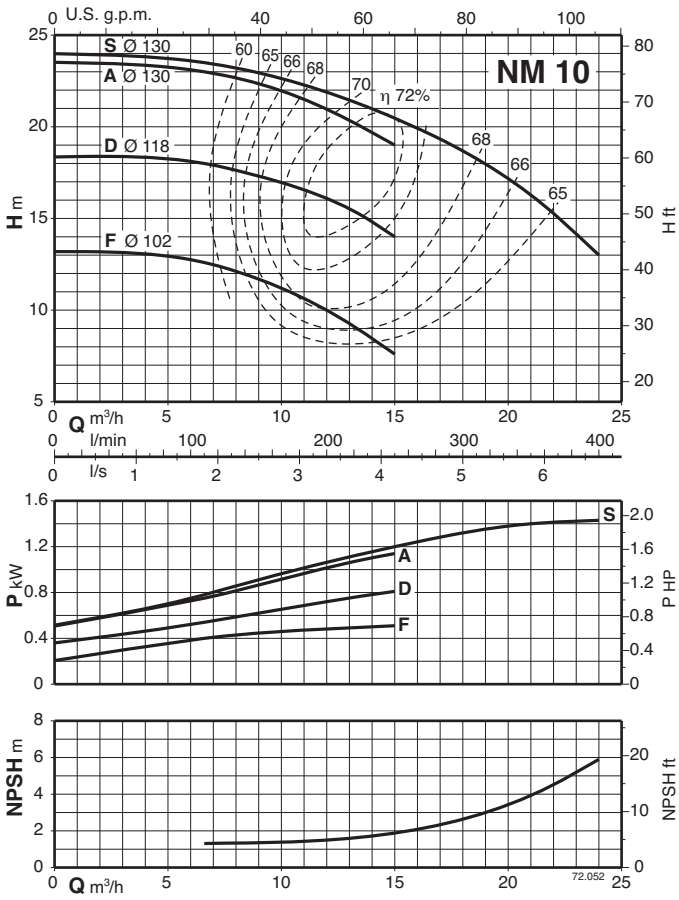

Characteristic curves $n \approx 2900$ rpm

1

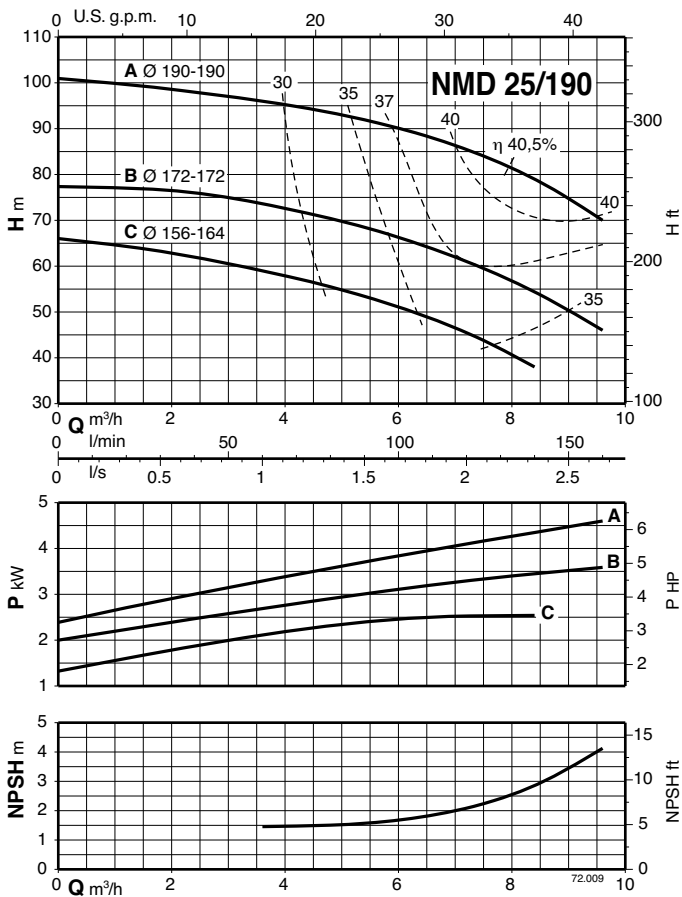
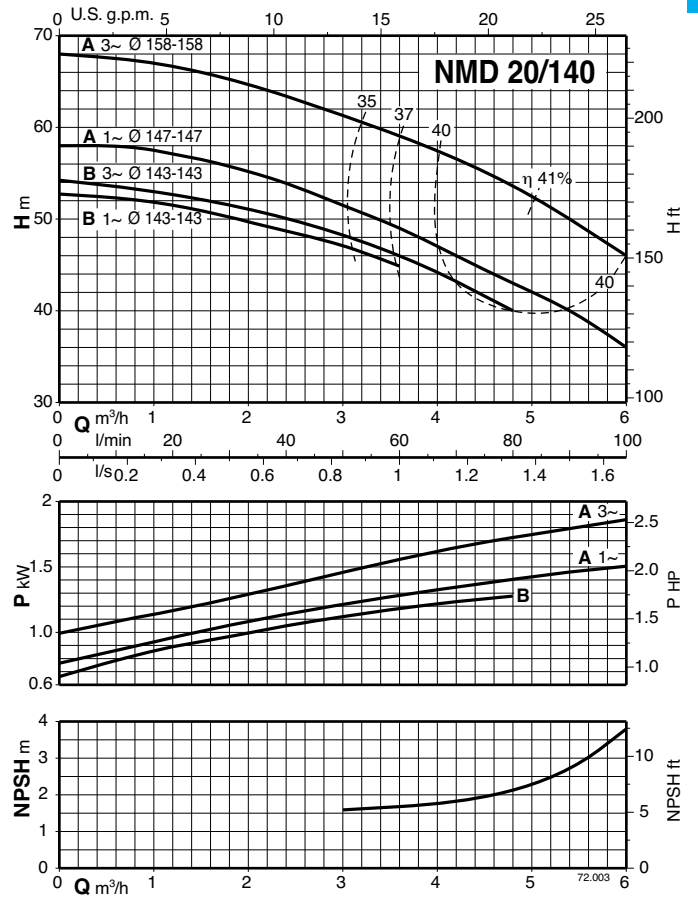
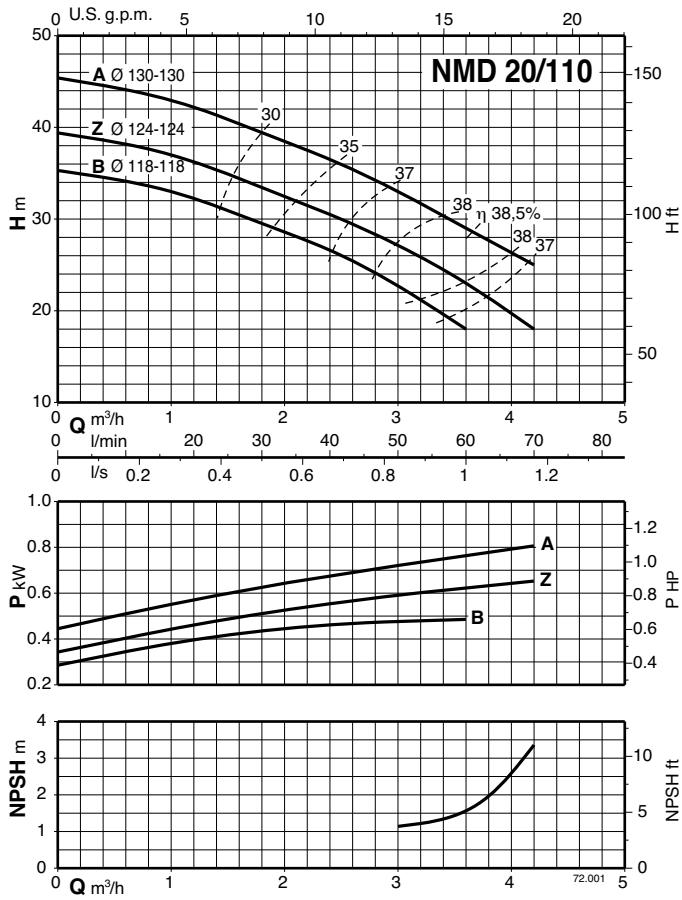

Characteristic curves $n \approx 2900$ rpm

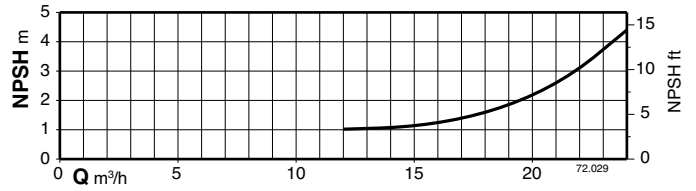
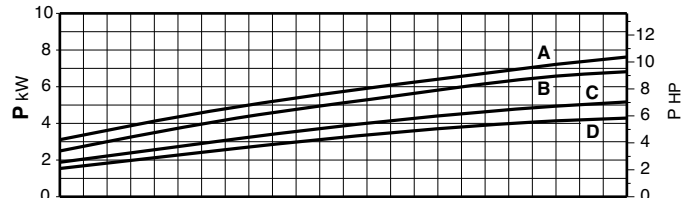
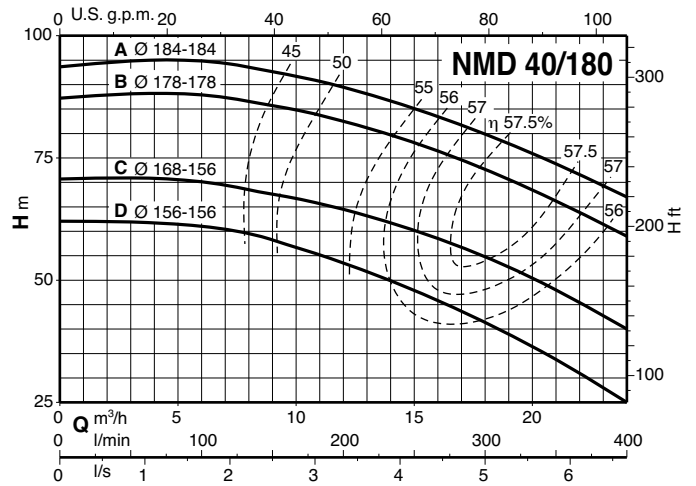
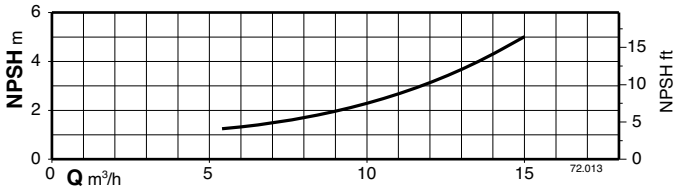
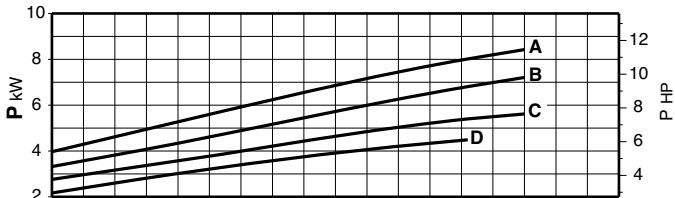
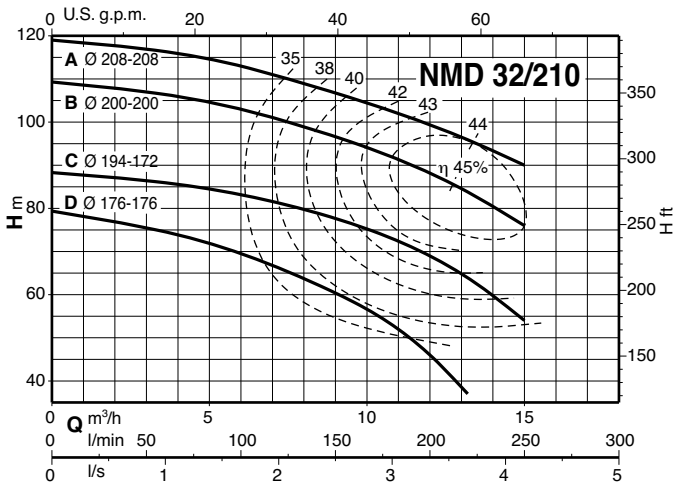

Dimensions and weights

1

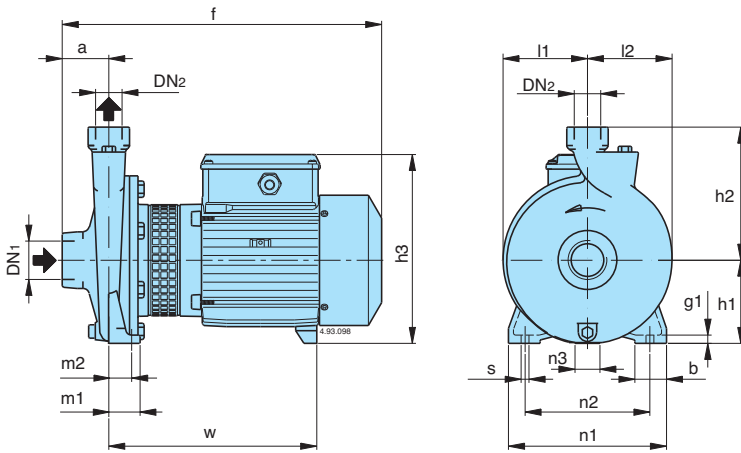

TYPE	NMM kg	NM kg	B-NM kg
NM 1/AE	8,7	8,6	
NM 2/B/A	14	13,1	
NM 2/S/A	14,2	13,3	
NM 2/A/A	15,1	14,2	
NM 3/CE	24	22,9	
NM 3/BE	26	25,1	
NM 3/A/A		29,1	
B- NM 20/160BE	19,9	18,4	21
B- NM 20/160AE	20,7	19,7	22,5
B- NM 25/12B/A	13,2	12,3	13,5
B- NM 25/12A/A	14,2	13,3	14,5
B- NM 25/160BE	20,4	19,7	22,8
B- NM 25/160AE	22,5	21,5	24
NM 25/20B/A		31,6	
NM 25/20A/A		40,9	
NM 25/20S/A		42,2	
B- NM 25/200B/A			35,7
B- NM 25/200A/A			43,7
B- NM 25/200S/A			45,2
NM 10/FE	19,3	18,5	
NM 10/DE	19,4	18,8	
NM 10/AE	20,2	19,3	
NM 10/SE	22,1	21,5	
NM 11/BE	24,7	24,1	
NM 11/A/A		28,1	
NM 12/D/A		33,5	
NM 12/C/A		42	
NM 12/A/A		43,5	
B- NM 17/HE	23	22,2	29,2
B- NM 17/GE	24,2	23,2	30,2
B- NM 17/F/A		28,2	35,2
B- NM 17/D/A		36,2	43,2

B-NM	NM	DN1 ISO 228	DN2 ISO 228	mm																
				a	f	h1	h2	h3	m1	m2	n1	n2	n3	b	s	l1	l2	w	g1	
	NM 1/AE	G 1	G 1	40	261	80	132	176	40	32	170	140	17	35	9,5	77	81	171	10	
	NM 2/A/A-S/A-B/A	G 1	G 1	45	305	95	150	207	40	32	190	160	17	35	9,5	87	90	203	10	
	NM 3/BE-CE	G 1	G 1	50	375	112	180	240	55	43	245	205	37	45	11,5	110	113	244	12	
	NM 3/A/A			415	284															
B- NM 20/160AE-BE	NM 20/160AE-BE	G 1 1/4	G 3/4	53	375	100	150	228	37,5	27,5	190	150	30	38	9,5	102	102	246	10	
B- NM 25/12A/A-B/A	NM 25/12A/A-B/A	G 1 1/2	G 1	56	313	90	140	199	37,5	27,5	170	130	9	38	9,5	85	88	195	10	
B- NM 25/160AE-BE	NM 25/160AE-BE	G 1 1/2	G 1	56	380	100	160	228	37,5	27,5	190	150	30	38	9,5	102	102	246	10	
	NM 25/20B/A	G 1 1/2	G 1	63	433	125	180	253	45	32,5	245	200	49	42	45	11,5	125	125	291	11
	NM 25/20A/A-S/A			460	295															
B- NM 25/200B/A		G 1 1/2	G 1	63	445	125	180	253	45	32,5	245	200	49	42	45	11,5	125	125	303	11
B- NM 25/200A/A-S/A				460	295															
	NM 10/SE-AE-DE-FE	G 2	G 1 1/4	63	382	100	150	228	50	35	190	140	30	50	13	90	97	239	14	
	NM 11/BE	G 2	G 1 1/4	70	400	112	170	240	50	35	210	160	37	50	15	103	110	247	14	
	NM 11/A/A			440	287															
	NM 12/D/A	G 2	G 1 1/4	70	440	132	190	260	50	35	240	190	47	50	15	125	127	287	14	
	NM 12/A/A-C/A			470	300															
B- NM 17/GE-HE	NM 17/GE-HE	G 2 1/2	G 2 1/2	80	417	112	160	240	50	35	210	160	37	50	14	96	113	257	14	
B- NM 17/F/A	NM 17/F/A			457	287															
B- NM 17/D/A	NM 17/D/A			480	295															

Dimensions and weights

NMD 20/110

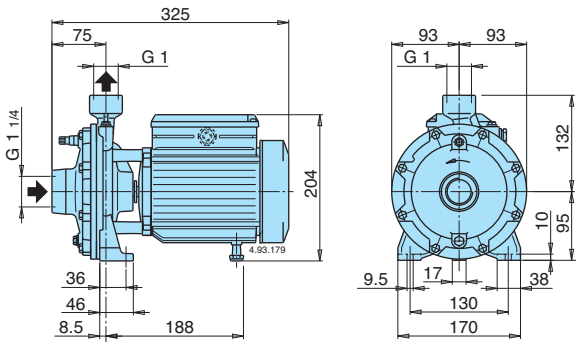

TYPE	NMDM kg	NMD kg	B-NMD kg
B- NMD 20/110B/A	13	12,1	13,4
B- NMD 20/110Z/A	14	13	14,2
B- NMD 20/110A/A	15,1	14,2	17,4

NMD 20/140 NMD 25/190

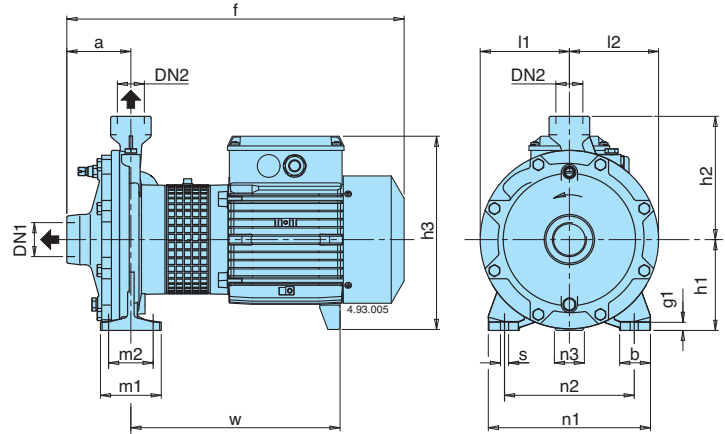

TYPE	NMDM kg	NMD kg	B-NMD kg
B- NMD 20/140BE	23,9	22,7	25,2
B- NMD 20/140AE	25,2	24,8	27,6
B- NMD 25/190C/A		42	45,7
B- NMD 25/190B/A		49,7	54
B- NMD 25/190A/A		51,5	55,5

B- NMD	NMD	DN1 ISO 228	DN2	mm																
				a	f	h1	h2	h3	m1	m2	n1	n2	n3	b	s	l1	l2	w	g1	
B- NMD 20/140AE-BE	NMD 20/140AE-BE	G 1 1/4	G 1	80	417	112	152	243	75	55	200	160	37	38	9,5	110	110	256	10	
B- NMD 25/190C/A	NMD 25/190C/A	G 1 1/2	G 1	97	487	140	180	268	100	70	240	190	50	49	50	14	133	133	314	13
B- NMD 25/190A/A-B/A	NMD 25/190A/A-B/A																			

NMD 32/210 NMD 40/180

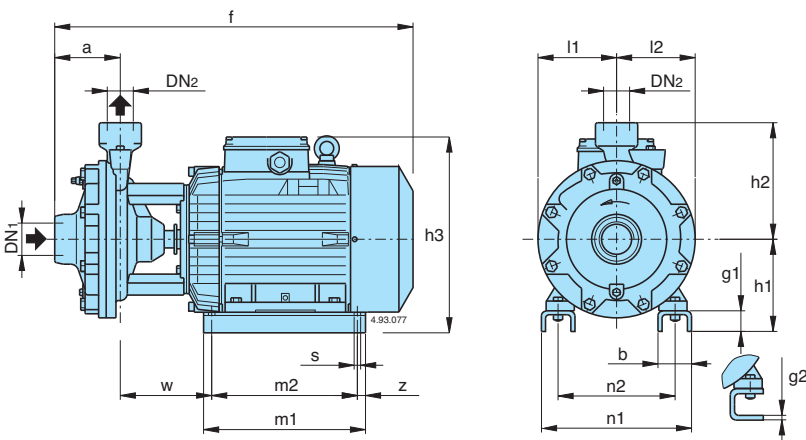

TYPE	NMD kg	B-NMD kg
B- NMD 32/210D/A	60,5	66,5
B- NMD 32/210C/A	71	77
B- NMD 32/210B/A	77	82,5
B- NMD 32/210A/A	99	105
B- NMD 40/180D/A	59,5	65,5
B- NMD 40/180C/A	70	76
B- NMD 40/180B/A	76	81,5
B- NMD 40/180A/A	97	102

B- NMD	NMD	DN1 ISO 228	DN2	mm																	
				a	f	h1	h2	h3	m1	m2	n1	n2	z	b	s	l1	l2	w	g1	g2	
B- NMD 32/210D/A	NMD 32/210D/A	G 2	G 1 1/4	110	530	155	293	205	175	194	140		54	10			139	-	6		
B- NMD 32/210B/A -C/A	NMD 32/210B/A -C/A				625	170	310	280	250	258	190	15	68	12	150	150	108	38	-	-	
B- NMD 32/210A/A	NMD 32/210A/A				625	170	355	298	268	286	216		70	12			152	38	-	-	
B- NMD 40/180D/A	NMD 40/180D/A	G 2	G 1 1/2	121	535	155	293	205	175	194	140		54	10			133	-	6		
B- NMD 40/180B/A -C/A	NMD 40/180B/A -C/A				630	170	310	280	250	258	190	15	68	12	145	145	102	38	-	-	
B- NMD 40/180A/A	NMD 40/180A/A				630	170	355	298	268	286	216		70	12			145	38	-	-	